



The V230i thermal transfer printer

Exceeding your expectations for performance *and* value



For flexible films and labels, the **V230i** easily delivers the performance and coding you expect but without the costs.



Scan the code to find out more about V-Series

Domino. Do more.

The smart solution to thermal transfer coding

The **V230i** prints high resolution codes, text and images onto flexible foils, films and labels.

Unlike other thermal transfer coders, the **V230i** uses *intelligent Technology* to meet all your general purpose coding needs while keeping your costs as low as possible.

The **i-Tech** Ribbon Drive uses up to 60% less ribbon per print and virtually eliminates downtime related to ribbon break due to its unique dancing arm tension control. Ribbon change is also quick and infrequent thanks to cassette loading of larger than standard ribbon rolls.

Being small and compact, the **V230i** will fit into most existing thermal transfer brackets, so you can quickly upgrade your existing equipment with minimal installation cost.

A diverse range of applications

Domino's **V230i** printers are ideal for goods packed using VFFS and HFFS machines and labellers across a wide range of food and healthcare applications:

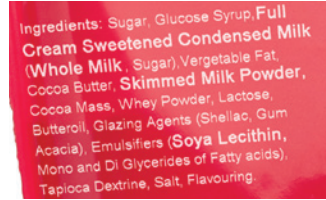

Print variable product information (e.g. ingredients lists) onto generic packaging. Easily highlight specific text in compliance with European food labelling regulations



Clean, taint free technology eliminates risk of product contamination



Clear, readable codes on every pack



Ribbons to suit a wide variety of packaging materials



Print variable text, logos and 2D codes over larger areas onto papers, films and labels



Greener credentials

Domino is committed to sound environmental practices and minimising the consumption of natural resources and energy and the creation of waste. We invest in our supply chain to ensure good social and environmental practice and we are supportive of developments to improve corporate accountability. Wherever practical our products are RoHS and WEEE compliant so that they are recyclable.

V230i

Innovative design has enabled a 40% reduction in weight (compared to previous models), helping to minimise environmental impact. Moreover, by enabling you to use up to 60% less ribbon and no compressed air, the Domino V230i also helps you to reduce your carbon footprint.

Performance to meet all applications

The V230i delivers the performance to meet all your general purpose printing and coding applications. Using a single, versatile system means you can also save on maintenance, inventory and training costs.

High Performing

The V230i can print consistently from low to high speeds (10-750mm/sec), exceeding the requirements of most production lines. The integrated print head heater ensures code quality is maintained, even at low operating temperatures.

Ribbons

A full range of Domino ribbon grades are available, allowing us to select the optimum grade, matching your packaging material and post processing requirements.



Versatile

Intermittent or Continuous printing modes are offered in the same printer, which can quickly convert between Left and Right handing to be ready to fit all configurations of VFFS / HFFs and labellers.

The V230i can also be used with a choice of interface devices to provide the level of control and security you require. You can even use an existing or shared PC based interface device to keep things simple on the production line.

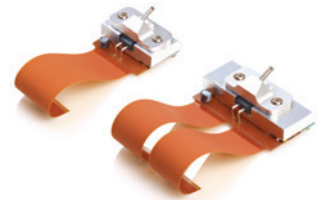

Capable

At 300 dpi, the V230i supports text, logos, dynamic bar codes and 2D codes with ease. It can also link seamlessly with a database to download specific information for each print. Two print head width options (32mm and 53mm) offer a range of print areas.



Lowest running costs – thanks to the **i-Tech** Ribbon Drive



Quickest ribbon changeovers guaranteed with ergonomic cassette design, easy ribbon loading and fast calibration

Efficient

Domino's **i-Tech** Ribbon Drive offers 4 ribbon save settings including 'Economy Mode' which allows you to use up to 60% less ribbon per print – without affecting print quality. As well as reducing ribbon costs this increases the effective ribbon roll length, significantly reducing costs associated with ribbon changeovers.

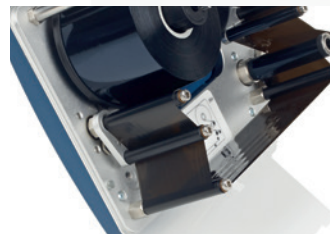

Reliable

Downtime caused by ribbon breaks is virtually eliminated by **i-Tech's** unique Dancing Arms, which constantly maintain ribbon tension. Additionally, the system does not need compressed air, further improving reliability and reducing running costs.

Easy to use

QuickStep User Interface - no action is more than 3 taps away

QuickStep is our unique, simplified operator interface that gets the printer in action as quickly as possible. No complex menus or parameters, just enter the job and away you go.

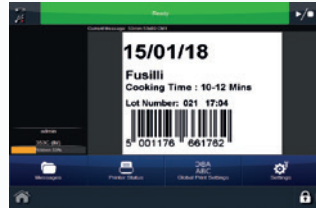

- Large user friendly icons and customisable home screen for quick access to favourite menus and settings
- Create and edit messages easily using the WYSIWYG drag and drop message editor at the line side
- Intuitive 3-tier menu structure makes **QuickStep** quick to learn and simple to remember
- Simplified Message Store and live WYSIWYG message preview to speed up changeovers and help eliminate coding selection errors

QuickDesign Lite - Simplifying message design

QuickDesign Lite is a single, easy to use Windows® application that gives you the flexibility of creating all types of coding messages from a remote PC. It also lays the foundation for providing increased automation of your coding needs.

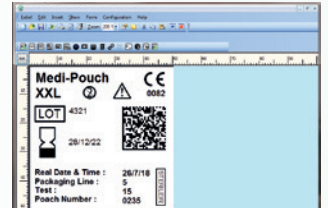

- Simply create, edit and send your message to your **V230i** by network or USB stick
- Allows simple highlighting of text in compliance with European food labelling regulations.
- Available for your **V230i** at no extra cost
- Easily upgradeable to **QuickDesign** for increase connectivity, control and Coding Automation capabilities

Quick to install and retro-fit

Compatible

The **V230i** is compact, allowing it to retro-fit simply into your existing thermal transfer brackets with use of a simple adapter block.

Retro-fit can be achieved in under an hour and because the **V230i** is also compatible with other label



Smart

AutoAlign, our unique (patent pending) head control technology, simplifies installation. At the touch of a button, the print head automatically aligns to the optimum position, without the need for shims or tools. There is also no need supply or connect compressed air.



creation and printer control software packages, you can get all the benefits of **V230i** without re-creating all your messages or changing the way you work.

Service and support excellence

With over 35 years as a preferred global partner to many manufacturers and OEMs, we have built an excellent reputation for our portfolio of coding solutions and for delivering the best service. From initial consulting, through commissioning to service and support, our people's expertise and understanding ensure we match your specific coding needs and meet your expectations as a partner you can rely on.

Domino. Do more.

A quick tour around the V230i

770m ribbon rolls for long production runs, with effective length of up to 1925m when Economy Mode is used.

Ribbon Drive reduces ribbon use by up to 60%

Continuous and Intermittent Mode functionality in the same printer – suitable for all applications

Connectivity with USB and Ethernet

Proven 'Dancing Arm' technology ensures no ribbon break-related downtime

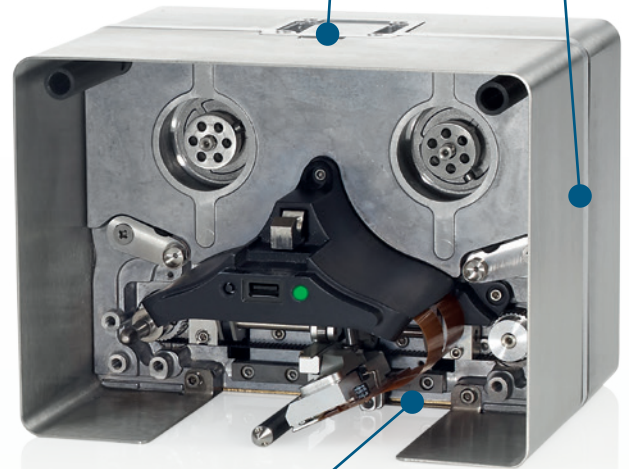
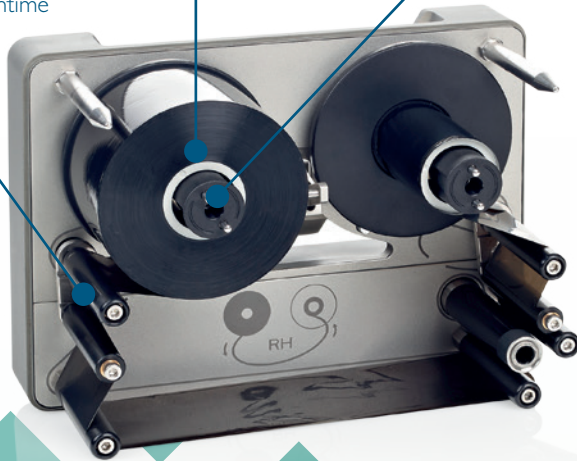

Two print head width options (32mm and 53mm) offer a range of print areas at 300dpi

A range of user interface options to suit your needs:

5.7" Portable **TouchPad** with **QuickStep** interface - quick connection via USB allows sharing between printers and safe storage



Use any alternative PC based interface and our **QuickStep** App to reduce cost and complexity on your production line

10.4" **TouchPanel** with **QuickStep** interface - control one or more networked printers; IP65 rated to withstand harsh environments



QuickStep includes Built in Label Creation capability to design messages line-side at no extra cost



Domino. Do more.

Technical Specification:

	V230i (32mm)	V230i (53mm)
Printer Specification		
Printing Modes	Intermittent and Continuous in the same printer	
Left hand / Right hand	Both options available (convertible with no extra parts in 15 minutes)	
Print resolution	300 dpi	
Maximum print area (IM)	32 mm x 55 mm	53 mm x 55 mm
Maximum print area (CM)	32 mm x 500 mm	53 mm x 500 mm
Print speed (max) (IM)	400 mm/s*	
Speed range (CM)	10 mm/s – 750 mm/s*	
Print repeat rate (max)	6 prints / s (with a 10mm long print)*	
Ribbon drive technology	i-Tech Ribbon Drive with unique Dancing Arm tension control	
Max ribbon length	770m (up to 1925m effective length with Economy Mode)	
Standard Ribbon widths	34 mm, 22 mm	55 mm, 34 mm
Ribbon save modes*		
Economy Mode	Variable in 1% increments up to 60%	
Retraction Mode	Less than 1 mm gap between prints	
Column Mode	Yes	
Stop mid print	Yes	
Print features		
Date code format	Yes	
Offsets	Yes	
Shift codes	Yes	
Serial number generation	Yes	
Fonts	Most true type fonts	
Dynamic bar codes	Yes	
2D codes	Yes	
Database linking	Yes	
Logos / bitmaps	Yes	
In-field text highlighting	Yes – via QuickDesign Lite	
Graphical User Interface	QuickStep , full colour Interface Intuitive navigation via, large, easy to read buttons and Icons. WYSIWYG print preview. Multilanguage support.	
Controller options	No dedicated controller required. Options: • Domino TouchPanel (10.4") • Domino TouchPad (5.7") • PC based interface (via Ethernet cable or network)	
Connectivity	Ethernet / USB x 2 / mini USB (service)	
Inputs	Print Go, Encoder	
Outputs	Error; Ready; Ribbon Low; Spare (software configurable volt free contacts)	
Special features	Master slave, macros, password, fastmode	
Label creation	Onboard and via QuickDesign Lite (PC application included)	
Electrical requirements	90v – 264v AC 50/60Hz, OR 24v DC (+/- 2%) at 5A (if direct)	
Dimensions	(W) 218mm x (H) 160mm x (D) 176mm	(W) 218mm x (H) 160mm x (D) 197mm
Weight	6.9kg	7.5kg
TouchPanel Specification		
Type	10.4 inch, full colour touchscreen (800x600 resolution) VESA mountable with optional brackets	
I.P. Protection	Certified to IP65	
Connectivity	2 x USB, Ethernet	
Electrical requirements	100/240 VAC, 50/60 Hz	
Dimensions	W 307mm x H 232mm x D 75mm	
Weight	2.8kg	
TouchPad Specification		
Type	5.7 inch, full colour touchscreen (640x480 resolution). Handheld with docking station included.	
Connectivity	USB, Ethernet, Mini USB (for power / data connection to printer)	
Dimensions	(W) 173mm x (H) 128mm x (D) 34mm excluding docking station, (W) 181mm x (H) 135mm x (D) 50mm including docking station	
Weight	0.4kg	
PSU Specification		
Standard:	W 67 mm x H 34 mm x D 166 mm / 0.4kg	
Dimensions / Weight	1.2m	
Cable length (PSU to printer)		
Optional Industrial Long Length:	W 117 mm x H 217 mm x D 63 mm / 1.0kg	
Dimensions / Weight	2.8m	
Cable length (PSU to printer)		
Environmental requirements	Temperature: 5°C to 40°C. Humidity: 20-80%, non condensing	

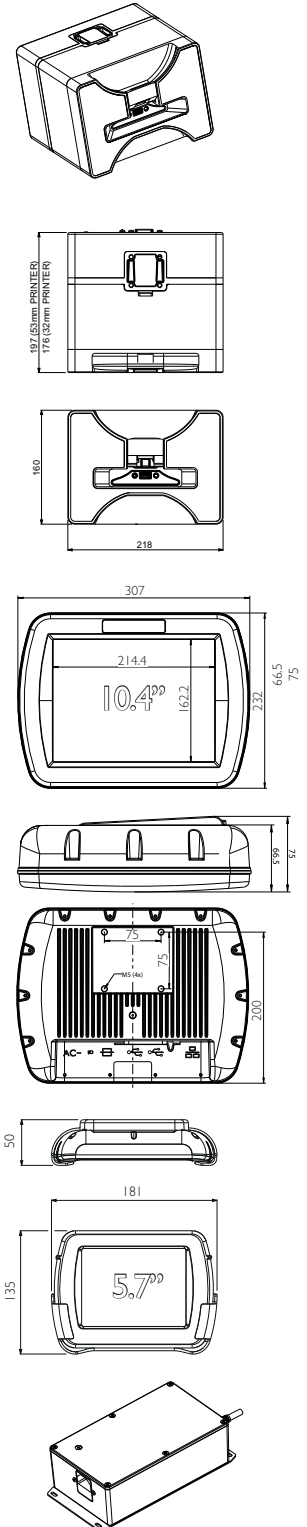

*Note: Capability is dependent upon application and substrate type as well as message length

www.domino-printing.com